



# PRACTIBOX



The **PRACTIBOX** series of drawer units consists of grey ABS structures and high mechanical strength drawers in transparent polystyrene.

Available in models of different depth and height, they share a standard 600 mm width that allows stacking in a wide range of combinations.

## DRAWERS



The drawers, made in high mechanical strength transparent polystyrene, are housed in the ABS container, designed to be positioned on Practibox shelves and in trolleys or fixed to the wall with anchor bolts.

## STACKING



Practibox drawer units are available in different depths and heights but have a standard width of 600 mm. This features means that modules of the same depth or lesser depth can be stacked, allowing a wide range of combinations.

## TILTED OPENING



Equipped with a handy tilting door opening, Practibox drawer units offer excellent access to the product.

## ORDER



Equipped with a practical handle, Practibox drawer units meet the most varied needs.

# Module width 600 mm

ARTICLE	WIDTH	DEPTH	HEIGHT	NUMBER OF TILTING DRAWERS	PACKAGING		UNIT PRICE €
					Qty. per pack.	Qty. per pallet	
A PR 9077 0001 LB 03510 0901	600	69	77	9	2	468	
					10		
B PR 6112 0001 LB 05315 0601	600	98	112	6	2	216	
					10		
C PR 5164 0001 LB 08022 0501	600	141	164	5	1	120	
					10		
D PR 4206 0001 LB 08028 0401	600	174	206	4	1	80	
					10		
E PR 3240 0001 LB 12134 0301	600	209	240	3	1	56	
					10		
F PR 2353 0001 LB 12150 0201	600	311	353	2	1	30	
					10		

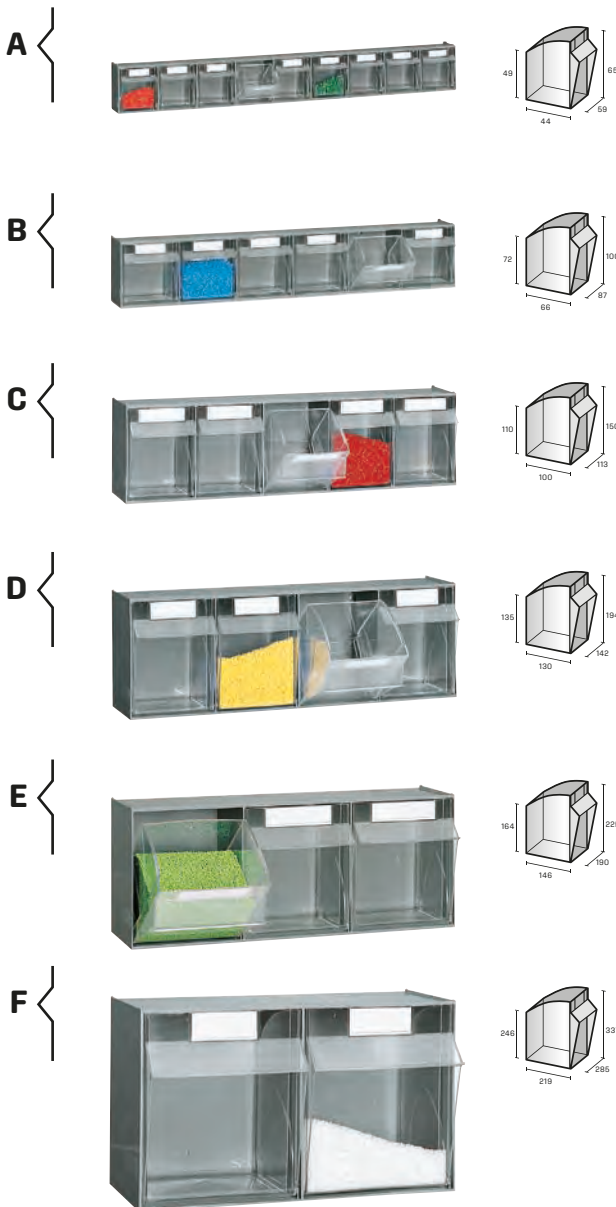

A - 9 drawers	
Pieces per pack / pallet	2 / 468
Package dimensions	610 x 155 x 95 H mm
Pallet dimensions	1300 x 1000 x 1600 H mm
LB035100901	Sheet of 9 labels included
B - 6 drawers	
Pieces per pack / pallet	2 / 216
Package dimensions	610 x 210 x 125 H mm
Pallet dimensions	1300 x 1000 x 1600 H mm
LB053150601	Sheet of 6 labels included
C - 5 drawers	
Pieces per pack / pallet	1 / 120
Package dimensions	610 x 155 x 175 H mm
Pallet dimensions	1300 x 1000 x 2000 H mm
LB080220501	Sheet of 5 labels included
D - 4 drawers	
Pieces per pack / pallet	1 / 80
Package dimensions	610 x 155 x 175 H mm
Pallet dimensions	1300 x 1000 x 2000 H mm
LB080280401	Sheet of 4 labels included
E - 3 drawers	
Pieces per pack / pallet	1 / 56
Package dimensions	610 x 225 x 255 H mm
Pallet dimensions	1300 x 1000 x 2000 H mm
LB121340301	Sheet of 3 labels included
F - 2 drawers	
Pieces per pack / pallet	1 / 30
Package dimensions	610 x 325 x 365 H mm
Pallet dimensions	1300 x 1000 x 2000 H mm
LB121500201	Sheet of 2 labels included

DATASHEET

iMilani srl reserves the right to alter the characteristics of products without notice. The values shown are nominal, with a +/- 1% tolerance for size, depending on the material, and a +/- 3% for weight.

# Module width 610 mm

iMICUBE

	ARTICLE	WIDTH	DEPTH	HEIGHT	NUMBER OF TILTING DRAWERS	PACKAGING		UNIT PRICE €
						Qty. per pack.	Qty. per pallet	
<b>A</b>	PRD050 015 0301	610	174	500	15	1	-	
<b>B</b>	PR D050 0001	610	150	500	-	1	-	
<b>C</b>	PRT BOX 5104	350	200	465	18	1	-	
<b>D</b>	PR ST90 0099	600				1	-	
	PR ST61 0099	600				1	-	
	PR ST51 0099	600				1	-	
	PR ST42 0099	600				1	-	
	PR ST32 0099	600				1	-	
	PR ST23 0099	600					1	-

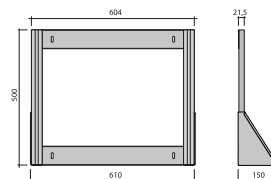

**A**



**B**



**C**



Release system



Galvanized stops



**D**

DATASHEET

**A**

Bench frame with drawers	1 x PR D050 0001
Drawers set	1 x PR 6112 0001
	1 x PR 5164 0001
	1 x PR 4206 0001
	1 x PR 4206 0001

**B**

Bench frame without drawers	1 x PR D050 0001
-----------------------------	------------------

**C**

Top Box case	18 drawers type PR 6112 0001
--------------	------------------------------

**D**

Galvanized stop for PR 9077...	1 x PR ST90 0099
Galvanized stop for PR 6112...	1 x PR ST61 0099
Galvanized stop for PR 5164...	1 x PR ST51 0099
Galvanized stop for PR 4206...	1 x PR ST42 0099
Galvanized stop for PR 3240...	1 x PR ST32 0099
Galvanized stop for PR 2353...	1 x PR ST23 0099

iMilani srl reserves the right to alter the characteristics of products without notice. The values shown are nominal, with a +/- 1% tolerance for size, depending on the material, and a +/- 3% for weight.

# Module width 600 mm

ARTICLE	WIDTH	DEPTH	HEIGHT	NUMBER OF TILTING DRAWERS	PACKAGING		UNIT PRICE €
					Qty. per pack.	Qty. per pallet	
<b>A</b> PR F030 0001	600	28	300	-	1	-	
<b>B</b> PR F030036 0101	600	78	308	36	1	-	
<b>C</b> PR F030021 0201	600	107	300	21	1	-	
<b>D</b> PR F030010 0101	600	150	328	10	1	-	



**B**



**A**

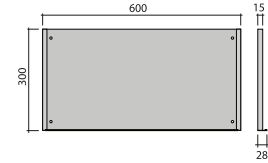
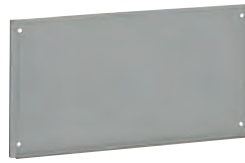

**C**



**D**



A	
Rear panel	1 x PR F030 0001
B	
Rear panel	1 x PR F030 0001
Drawers set	4 x PR 9077 0001
C	
Rear panel	1 x PR F030 0001
Drawers set	1 x PR 9077 0001
	2 x PR 6112 0001
D	
Rear panel	1 x PR F030 0001
Drawers set	2 x PR 5164 0001

DATASHEET

iMilani srl reserves the right to alter the characteristics of products without notice. The values shown are nominal, with a +/- 1% tolerance for size, depending on the material, and a +/- 3% for weight.

# Module width 600 mm

iMICUBE

ARTICLE	WIDTH	DEPTH	HEIGHT	NUMBER OF TILTING DRAWERS	PACKAGING		UNIT PRICE €
					Qty. per pack.	Qty. per pallet	
<b>A</b> PR F050 0001	600	28	500	-	1	-	
<b>B</b> PR F050054 0101	600	78	500	54	1	-	
<b>C</b> PR F050036 0201	600	107	36	1	-		
<b>D</b> PR F050015 0301	600	183	500	15	1	-	

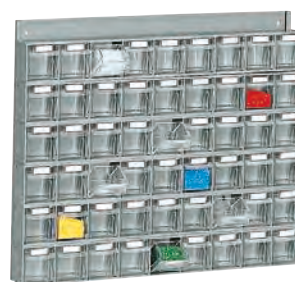
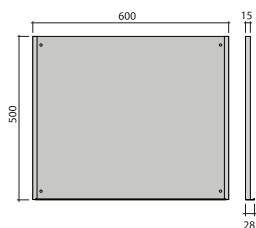

DATASHEET

**A**

Rear panel	1 x PR F050 0001
------------	------------------

**B**

Rear panel	1 x PR F050 0001
Drawers set	6 x PR 9077 0001

**C**

Rear panel	1 x PR F050 0001
Drawers set	2 x PR 9077 0001
	3 x PR 6112 0001

**D**

Rear panel	1 x PR F050 0001
Drawers set	1 x PR 6112 0001
	1 x PR 5164 0001
	1 x PR 4206 0001

iMilani srl reserves the right to alter the characteristics of products without notice. The values shown are nominal, with a +/- 1% tolerance for size, depending on the material, and a +/- 3% for weight.

# Module width 600 mm

ARTICLE	WIDTH	DEPTH	HEIGHT	NUMBER OF TILTING DRAWERS	PACKAGING		UNIT PRICE €
					Qty. per pack.	Qty. per pallet	
A PR F065 0001	600	28	650	-	1	-	
B PR F065072 0101	600	78	650	72	1	-	
C PR F065039 0201	600	107	650	39	1	-	
D PR F065028 0201	600	150	664	28	1	-	



**B**



**A**

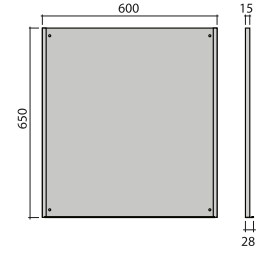

**C**



**D**



A	
Rear panel	1 x PR F065 0001
B	
Rear panel	1 x PR F065 0001
Drawers set	8 x PR 9077 0001
C	
Rear panel	1 x PR F065 0001
Drawers set	1 x PR 9077 0001
	5 x PR 6112 0001
C	
Rear panel	1 x PR F065 0001
Drawers set	3 x PR 6112 0001
	2 x PR 5164 0001

DATASHEET

iMilani srl reserves the right to alter the characteristics of products without notice. The values shown are nominal, with a +/- 1% tolerance for size, depending on the material, and a +/- 3% for weight.

# Module width 600 mm

iMICUBE

ARTICLE	WIDTH	DEPTH	HEIGHT	NUMBER OF TILTING DRAWERS	PACKAGING		UNIT PRICE €
					Qty. per pack.	Qty. per pallet	
<b>A</b> PR F100 0001	600	41	1000	-	1	-	
<b>B</b> PR F100 084 0201	600	113	1022	84	1	-	
<b>C</b> PR F100 054 0101	600	113	1008	54	1	-	
<b>D</b> PR F100 029 0401	600	224	1000	29	1	-	
<b>E</b> PR DBAS 0001	600	300	100		1		

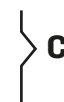
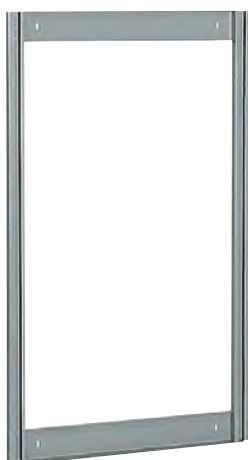
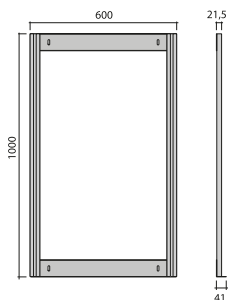

## DATASHEET

### A

Rear panel	1 x PR F100 0001
------------	------------------

### B

Rear panel	1 x PR F100 0001
Drawers set	6 x PR 9077 0001
	5 x PR 6112 0001

### B

Rear panel	1 x PR F100 0001
Drawers set	9 x PR 6112 0001

### D

Rear panel	1 x PR F100 0001
Drawers set	2 x PR 6112 0001
	2 x PR 5164 0001
	1 x PR 4206 0001
	1 x PR 3240 0001

### E

Optional base for shelf	1 x PR DBAS 0001
-------------------------	------------------

iMilani srl reserves the right to alter the characteristics of products without notice. The values shown are nominal, with a +/- 1% tolerance for size, depending on the material, and a +/- 3% for weight.



# Module width 600 mm

ARTICLE	WIDTH	DEPTH	HEIGHT	NUMBER OF TILTING DRAWERS	PACKAGING		UNIT PRICE €
					Qty. per pack.	Qty. per pallet	
A PR F150 0001	600	41	1500	-	1	-	
B PR F150123 0201	600	113	1500	123	1	-	
C PR F150084 0101	600	113	1568	84	1	-	
D PR F150064 0501	600	224	1540	64	1	-	
E PR DBAS 0001	600	300	100	-	1	-	



**B**



**A**

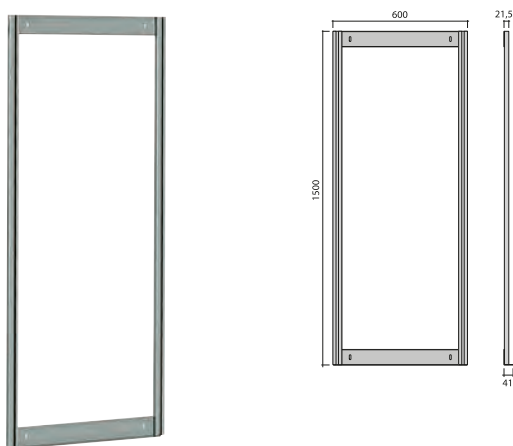

**C**



**D**



**E**



A	
Rear panel	1 x PR F150 0001
B	
Rear panel	1 x PR F150 0001
Drawers set	9 x PR 9077 0001
	7 x PR 6112 0001
C	
Rear panel	1 x PR F150 0001
Drawers set	14 x PR 6112 0001
D	
Rear panel	1 x PR F150 0001
Drawers set	2 x PR 9077 0001
	4 x PR 6112 0001
	3 x PR 5164 0001
	1 x PR 4206 0001
	1 x PR 3240 0001
E	
Optional base for shelf	1 x PR DBAS 0001

DATASHEET

iMilani srl reserves the right to alter the characteristics of products without notice. The values shown are nominal, with a +/- 1% tolerance for size, depending on the material, and a +/- 3% for weight.

# Module width 600 mm

iMICUBE

ARTICLE	WIDTH	DEPTH	HEIGHT	NUMBER OF TILTING DRAWERS	PACKAGING		UNIT PRICE €
					Qty. per pack.	Qty. per pallet	
<b>A</b> PR F175 0001	600	41	1750	-	1	-	
<b>B</b> PR F175132 0201	600	113	1750	132	1	-	
<b>C</b> PR F175099 0201	600	113	1750	99	1	-	
<b>D</b> PR F175066 0501	600	224	1750	66	1	-	
<b>E</b> PR DBAS 0001	600	300	100		1		

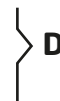
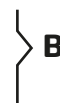
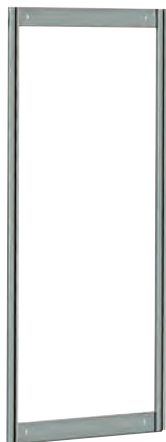
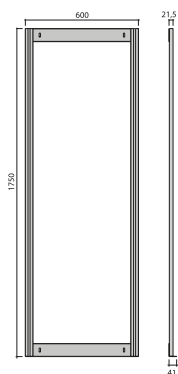

## DATASHEET

### A

Rear panel	1 x PR F175 0001
------------	------------------

### B

Rear panel	1 x PR F175 0001
Drawers set	8 x PR 9077 0001
	10 x PR 6112 0001

### C

Rear panel	1 x PR F175 0001
Drawers set	1 x PR 9077 0001
	15 x PR 6112 0001

### D

Rear panel	1 x PR F175 0001
Drawers set	1 x PR 9077 0001
	6 x PR 6112 0001
	2 x PR 5164 0001
	2 x PR 4206 0001
	1 x PR 3240 0001

### E

Optional base for shelf	1 x PR DBAS 0001
-------------------------	------------------

iMilani srl reserves the right to alter the characteristics of products without notice. The values shown are nominal, with a +/- 1% tolerance for size, depending on the material, and a +/- 3% for weight.

# Module width 600 mm

ARTICLE	WIDTH	DEPTH	HEIGHT	NUMBER OF TILTING DRAWERS	PACKAGING		UNIT PRICE €
					Qty. per pack.	Qty. per pallet	
A PR F195 0001	600	41	1950	-	1	-	
B PR F195144 0201	600	113	1960	144	1	-	
C PR F195100 0301	600	156	1950	100	1	-	
D PR F195043 0401	600	326	1989	43	1	-	
E PR DBAS 0001	600	300	100	-	1	-	



**B**



**A**

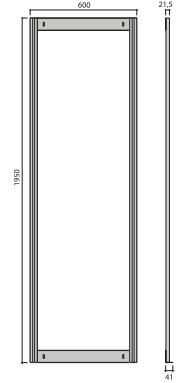

**C**



**D**



**E**



A	
Rear panel	1 x PR F195 0001
B	
Rear panel	1 x PR F195 0001
Drawers set	8 x PR 9077 0001
	12 x PR 6112 0001
C	
Rear panel	1 x PR F195 0001
Drawers set	3 x PR 9077 0001
	8 x PR 6112 0001
	5 x PR 5164 0001
D	
Rear panel	1 x PR F195 0001
Drawers set	6 x PR 5164 0001
	2 x PR 4206 0001
	1 x PR 3240 0001
	1 x PR 2353 0001
E	
Optional base for shelf	1 x PR DBAS 0001

DATASHEET

iMilani srl reserves the right to alter the characteristics of products without notice. The values shown are nominal, with a +/- 1% tolerance for size, depending on the material, and a +/- 3% for weight.

# Module width 600 mm

iMICUBE

Module depth 325 mm

ARTICLE	WIDTH	DEPTH	HEIGHT	NUMBER OF TILTING DRAWERS	PACKAGING		UNIT PRICE €
					Qty. per pack.	Qty. per pallet	
<b>A</b> PR D150 0001	600	325	1500	-	1	-	
<b>B</b> PR D150 114 0201	600	325	1500	114	1	-	
<b>C</b> PR D150 078 0101	600	325	1556	78	1	-	
<b>D</b> PR D150 058 0501	600	325	1528	58	1	-	

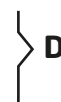
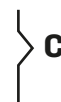
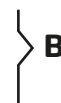
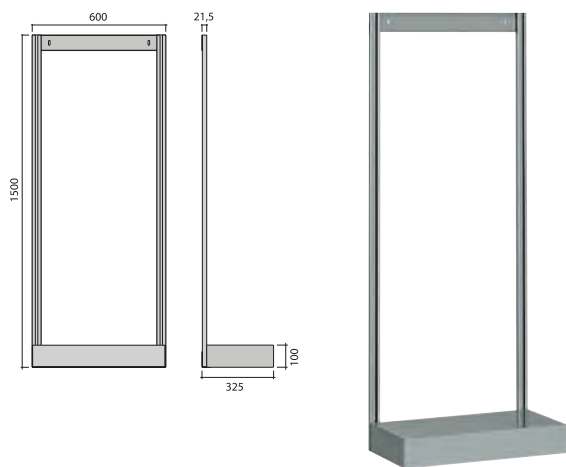

## DATASHEET

### A

Rear panel with base	1 x PR D150 0001
----------------------	------------------

### B

Rear panel with base	1 x PR D150 0001
Drawers set	8 x PR 9077 0001
	7 x PR 6112 0001

### C

Rear panel with base	1 x PR D150 0001
Drawers set	13 x PR 6112 0001

### D

Rear panel with base	1 x PR D150 0001
Drawers set	2 x PR 9077 0001
	3 x PR 6112 0001
	3 x PR 5164 0001
	1 x PR 4206 0001
	1 x PR 3240 0001

iMilani srl reserves the right to alter the characteristics of products without notice. The values shown are nominal, with a +/- 1% tolerance for size, depending on the material, and a +/- 3% for weight.

# Module width 600 mm

Module depth 325 mm

ARTICLE	WIDTH	DEPTH	HEIGHT	NUMBER OF TILTING DRAWERS	PACKAGING		UNIT PRICE €
					Qty. per pack.	Qty. per pallet	
<b>A</b> PR D175 0001	600	325	1750	-	1	-	
<b>B</b> PR D175 112 0301	600	325	1786	112	1	-	
<b>C</b> PR D175 062 0501	600	325	1750	62	1	-	
<b>D</b> PR D175 057 0301	600	325	1770	57	1	-	



**B**



**A**

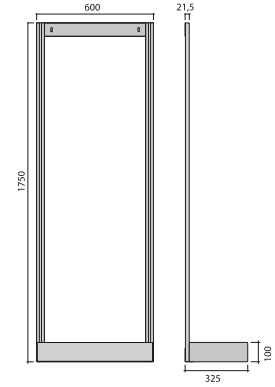
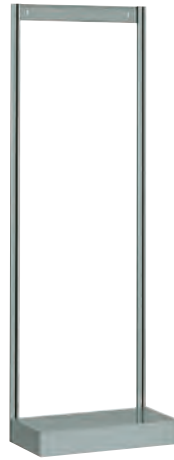

**C**



**D**



A	
Rear panel with base	1 x PR F175 0001
B	
Rear panel with base	1 x PR D175 0001
Drawers set	6 x PR 9077 0001
	8 x PR 6112 0001
	2 x PR 5164 0001
C	
Rear panel with base	1 x PR D175 0001
Drawers set	2 x PR 9077 0001
	3 x PR 6112 0001
	3 x PR 5164 0001
	2 x PR 4206 0001
	1 x PR 3240 0001
D	
Rear panel with base	1 x PR D175 0001
Drawers set	5 x PR 6112 0001
	3 x PR 5164 0001
	3 x PR 4206 0001

DATASHEET

iMilani srl reserves the right to alter the characteristics of products without notice. The values shown are nominal, with a +/- 1% tolerance for size, depending on the material, and a +/- 3% for weight.

# Module width 600 mm

iMICUBE

Module depth 325 mm

ARTICLE	WIDTH	DEPTH	HEIGHT	NUMBER OF TILTING DRAWERS	PACKAGING		UNIT PRICE €
					Qty. per pack.	Qty. per pallet	
<b>A</b> PR D195 0001	600	325	1950	-	1	-	
<b>B</b> PR D195 117 0401	600	325	1950	117	1	-	
<b>C</b> PR D195 066 0501	600	325	1950	66	1	-	
<b>D</b> PR D195 061 0301	600	325	1976	61	1	-	

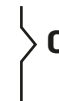
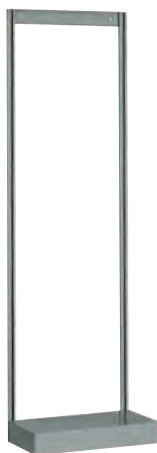
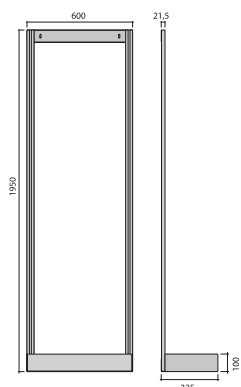

## DATASHEET

A	
Rear panel with base	1 x PR D195 0001
B	
Rear panel with base	1 x PR D195 0001
Drawers set	6 x PR 9077 0001
	9 x PR 6112 0001
	1 x PR 5164 0001
	1 x PR 4206 0001
C	
Rear panel with base	1 x PR D195 0001
Drawers set	2 x PR 9077 0001
	3 x PR 6112 0001
	3 x PR 5164 0001
	3 x PR 4206 0001
	1 x PR 3240 0001
D	
Rear panel with base	1 x PR D195 0001
Drawers set	5 x PR 6112 0001
	3 x PR 5164 0001
	4 x PR 4206 0001

iMilani srl reserves the right to alter the characteristics of products without notice. The values shown are nominal, with a +/- 1% tolerance for size, depending on the material, and a +/- 3% for weight.

# Swivel structure

ARTICLE	WIDTH	DEPTH	HEIGHT	NUMBER OF TILTING DRAWERS	PACKAGING		UNIT PRICE €
					Qty. per pack.	Qty. per pallet	
<b>A</b> PR R186260 0401	900	900	1865	260	1	-	
<b>B</b> PR R161 0001	900	900	1615	-	1	-	
<b>C</b> PR R186 0001	900	900	1865	-	1	-	
<b>D</b> PR R206 0001	900	900	2065	-	1	-	



**A**

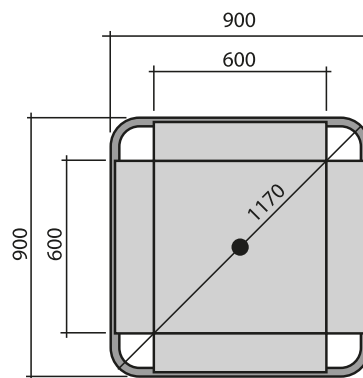

**B**  
**C**  
**D**

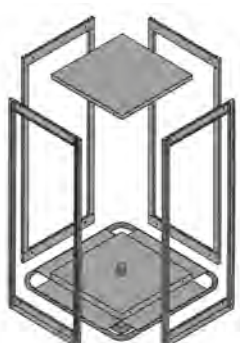

The Practibox swivel shelf consists of a 360° swivel base that houses 4 Practibox drawer unit holder frames, available in 3 different heights. Capacious, robust, practical – characteristics that make it usable in both large and small spaces.

The swivel base must be fixed to the floor

iMilani srl reserves the right to alter the characteristics of products without notice. The values shown are nominal, with a +/- 1% tolerance for size, depending on the material, and a +/- 3% for weight.

A	
Swivel structure with 4 frames	1 x PR R186 0001
Drawers set	2 x PR 9077 0001
	18 x PR 6112 0001
	22 x PR 5164 0001
	6 x PR 4206 0001
B	
Swivel structure with 4 frames	1 x PR R161 0001
C	
Swivel structure with 4 frames	1 x PR R186 0001
D	
Swivel structure with 4 frames	1 x PR R206 0001

DATASHEET



14.021

14.022

14.023

14.024

14.025

14.026

14.027

14.028

14.029

14.030

14.027 24

14.028

14.030

14.031

14.032

14.033

14.034

14.025

14.027 24

14.028

14.030

14.031

14.032

14.033

14.034

14.032

14.033

14.033

14.034

14.035

14.036

14.037

14.037 14

14.038

14.038

14.039

14.040

14.041

14.039 14

14.039

14.038

14.039

14.040

14.041

14.039 36

14.040

14.041 32

14.042

14.043

14.039

14.039 36

14.040

14.041 32

14.042

14.043

14.041

14.042

14.043 32

14.044

14.044 40

14.045

14.046





# Cabinets with removable frames

iMICUBE

## Extractable frame holder 400 kg

ARTICLE	WIDTH	DEPTH	HEIGHT	NUMBER OF TILTING DRAWERS	PACKAGING		UNIT PRICE €
					Qty. per pack.	Qty. per pallet	
<b>A</b> PR COOL 5001	1073	705	2000	-	1	-	
<b>B</b> PR COOL 7001	1481	705	2000	-	1	-	
<b>C</b> PR C000 0401	-	705	1900	1765	1	-	
<b>D</b> PR FX 0099	-	-	-	-	2	-	

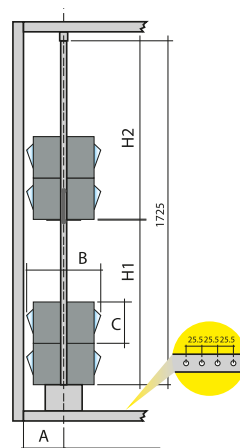

A  
B

### DATASHEET

#### A

Cabinet for extractable frames with lock	PR COOL 5001
Usable cabinet width mm	967

#### B

Cabinet for extractable frames with lock	PR COOL 7001
Usable cabinet width mm	1375

#### C

Removable frame capacity 400 kg	PR C000 0401
---------------------------------	--------------

#### D

Pair of anchor bolts for fixing a side unit	PR FIX 0099
---------------------------------------------	-------------

Drawer unit	A	B*	C	Q.ty H1	Q.ty H2
PR 2353 ...	330,5	650	352	2	2
PR 3240 ...	228,5	445	241	3	3
PR 4206 ...	203,5	380	207	4	4
PR 5164 ...	177,5	315	164	5	5
PR 6112 ...	126,5	225	112	7	8
PR 9077 ...	101,5	170	77	10	11

B\* - see usable width of cabinets without removable frames

\* see useful width of cabinets without drawers



C



D

 The cabinet comes assembled  
The cabinet must be fixed to the floor

iMilani srl reserves the right to alter the characteristics of products without notice. The values shown are nominal, with a +/- 1% tolerance for size, depending on the material, and a +/- 3% for weight.

# Compositions with and without drawers

Extractable frame 400 kg

ARTICLE	WIDTH	DEPTH	HEIGHT	NUMBER OF TILTING DRAWERS	PACKAGING		UNIT PRICE €
					Qty. per pack.	Qty. per pallet	
A PR C41L 5401	1073	705	2000	-	1	-	
B PR C41L720 5401	1073	705	2000	720	1	-	
C PR C32L 5401	1073	705	2000	-	1	-	
D PR C32L380 5401	1073	705	2000	380	1	-	
E PR C33L 5401	1073	705	2000	-	1	-	
F PR C33L344 5401	1073	705	2000	344	1	-	



A  
B

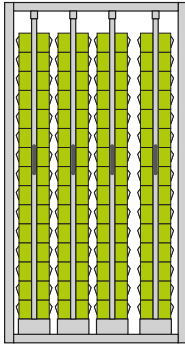

C  
D

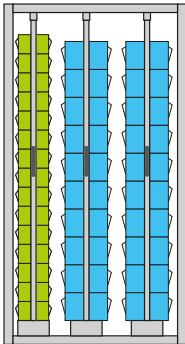

E  
F

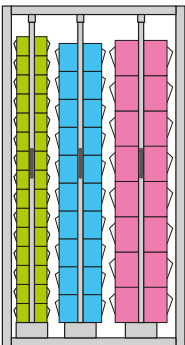

The cabinet must be fixed to the floor

iMilani srl reserves the right to alter the characteristics of products without notice. The values shown are nominal, with a +/- 1% tolerance for size, depending on the material, and a +/- 3% for weight.

<b>A</b>	
Cabinet with 4 extractable frames with lock	1x PRC41L 5401
<b>B</b>	
Cabinet with 4 extractable frames with lock	1x PRC41L 5401
Drawers set	120 x PR 6112 001
<b>C</b>	
Cabinet with 3 extractable frames with lock	1x PRC32L 5401
<b>D</b>	
Cabinet with 3 extractable frames with lock	1x PRC32L 5401
Drawers set	30 x PR 6112 001
	40 x PR 5164 001
<b>E</b>	
Cabinet with 3 extractable frames with lock	1x PRC33L 5401
<b>F</b>	
Cabinet with 3 extractable frames with lock	1x PRC33L 5401
Drawers set	30 x PR 6112 001
	20 x PR 5164 001
	16 x PR 4206 001

DATASHEET

# Compositions with and without drawers

iMICUBE

Extractable frame 400 kg

ARTICLE	WIDTH	DEPTH	HEIGHT	NUMBER OF TILTING DRAWERS	PACKAGING		UNIT PRICE €
					Qty. per pack.	Qty. per pallet	
<b>A</b> PR C51L 7401	1481	705	2000	-	1	-	
<b>B</b> PR C51L900 7401	1481	705	2000	900	1	-	
<b>C</b> PR C42L 7401	1481	705	2000	-	1	-	
<b>D</b> PR C42L480 7401	1481	705	2000	480	1	-	
<b>E</b> PR C31L 7401	1481	705	2000	-	1	-	
<b>F</b> PR C31L192 7401	1481	705	2000	192	1	-	

DATASHEET

<b>A</b>	
Cabinet with 5 extractable frames with lock	1x PR C51L 7401
<b>B</b>	
Cabinet with 5 extractable frames with lock	1x PR C51L 7401
Drawers set	150 x PR 6112 001
<b>C</b>	
Cabinet with 4 extractable frames with lock	1x PR C42L 7401
<b>D</b>	
Cabinet with 4 extractable frames with lock	1x PR C42L 7401
Drawers set	30 x PR 6112 001
	60 x PR 5164 001
<b>E</b>	
Cabinet with 3 extractable frames with lock	1x PR C31L 7401
<b>F</b>	
Cabinet with 3 extractable frames with lock	1x PR C31L 7401
Drawers set	48 x PR 4206 001

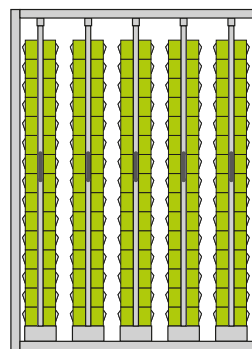

A  
B

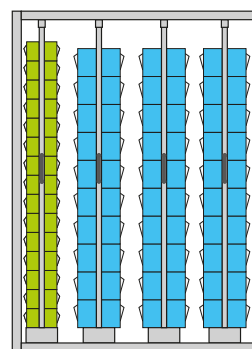

C  
D

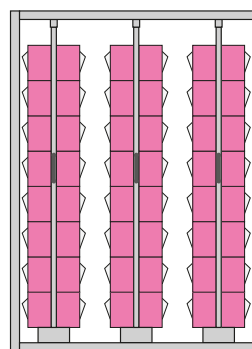

E  
F

The cabinet must be fixed to the floor

iMilani srl reserves the right to alter the characteristics of products without notice. The values shown are nominal, with a +/- 1% tolerance for size, depending on the material, and a +/- 3% for weight.