

**NOME:**

ACOUSTIC FURNITURE TAILOR MADE

**DESCRIZIONE:**

Arredi fonoassorbenti, lavorazione sartoriale, modello TAILOR MADE, composti da struttura multistrato irrigidita e stratigrafia di fibra fonoassorbente in poliestere

**APPLICAZIONI:**

- Autoportante

**\* PHONE BOOTH ROUND:**

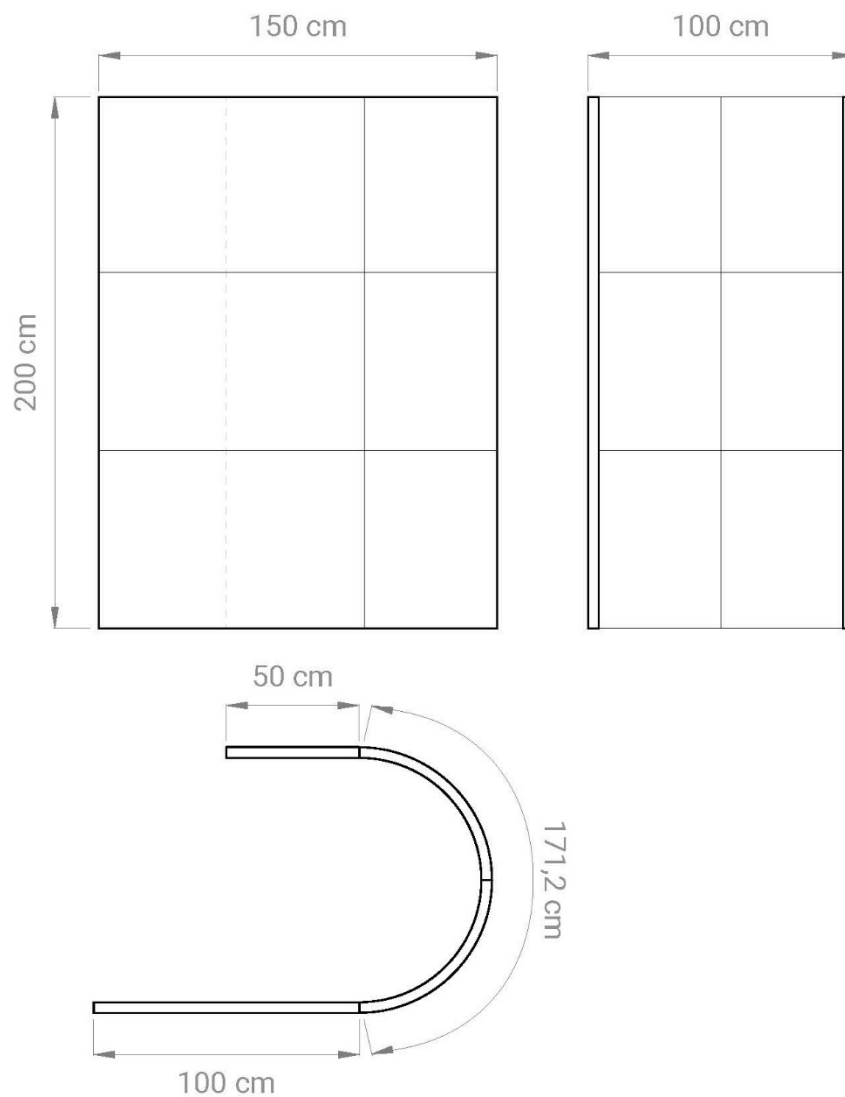

**DIMENSIONI:**

- L 100 x H 200 x P 150 cm

NOTE: *Disponibili ulteriori forme e dimensioni su richiesta*

\* PHONE BOOTH SPIKE:

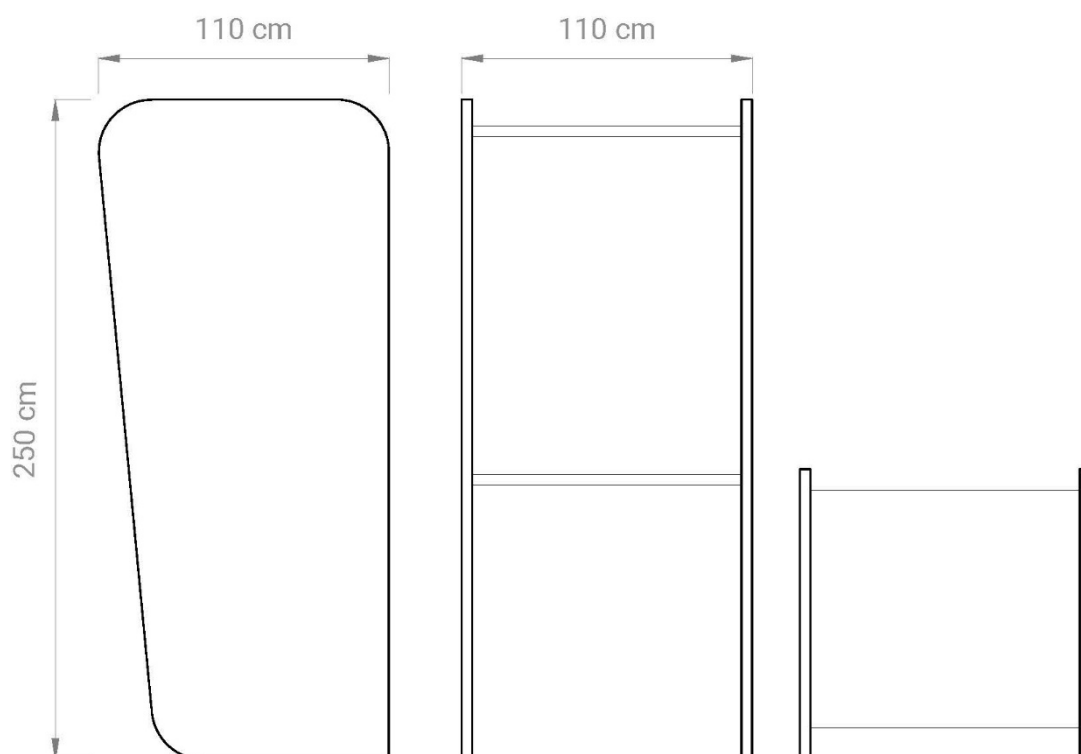

**DIMENSIONI:**

• L 110 x H 250 x P 110 cm

NOTE: *Disponibili ulteriori forme e dimensioni su richiesta*

\* CHAT BOOTH:

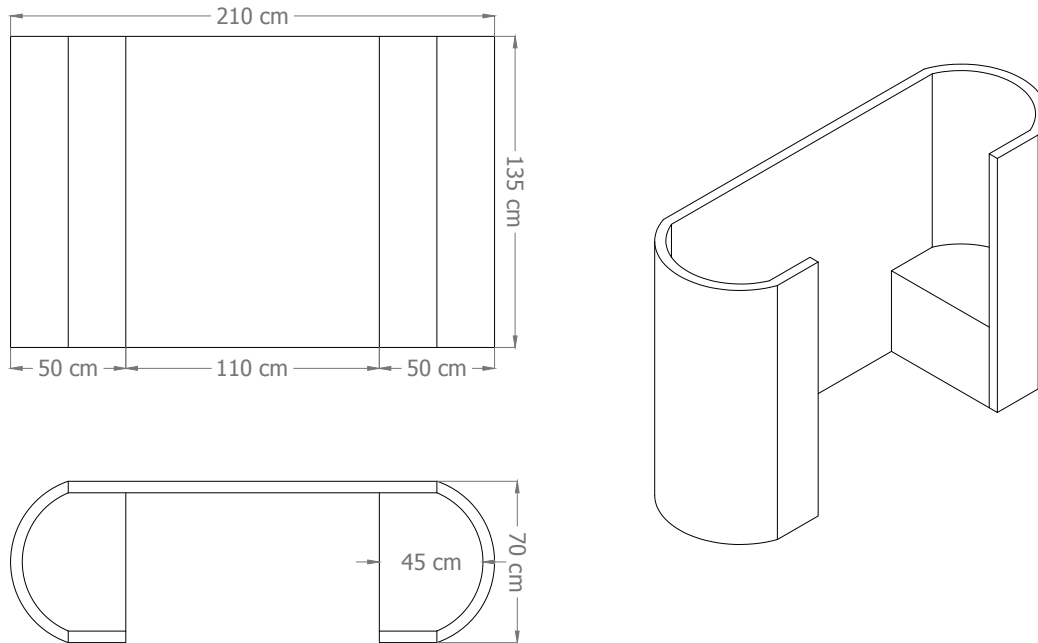

**DIMENSIONI:**

• L 210 x H 135 x P 70 cm

NOTE: *Disponibili ulteriori forme e dimensioni su richiesta*

**\* DESK:**

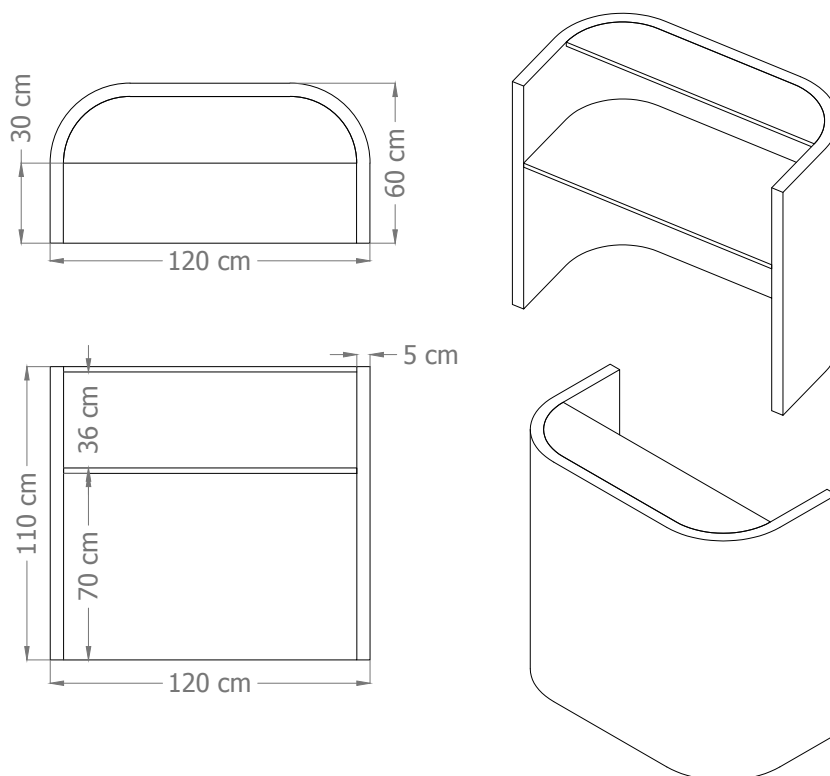

**DIMENSIONI:**

- L 120x H 110 x P 60 cm

NOTE: *Disponibili ulteriori forme e dimensioni su richiesta*

## COMPOSIZIONE:

- Anima: materiale fonoassorbente composto da materiale riciclato 100%, fibre in poliestere

Reazione al fuoco: B-s2, d0

Classe fumo: F1

Certificato: Oekotex

## • Finiture:

- **Trevira CS** - 100% poliestere

Reazione al fuoco: **Class 1**

Certificato: **Oekotex**

- **ECOfelt** - 90% lana, 10% poliestere

- **PETfelt** - 100% PET

- **Tweed** - 75% lana, 25% poliammide

Reazione al fuoco: **Class 1**

- **Velvet** - 100% poliestere

## RICICLABILITÀ:

Pannello di materiale riciclato e riciclabile alla fine della sua vita, senza dover separare anima e finitura

## MANUTENZIONE:

Pannello pulibile con detergenti specifici

## CERTIFICAZIONI:

• **CLASSE REAZIONE AL FUOCO:**

B-s2, d0



• **MARCATURA CE:**

B-s1, d0



• **CERTIFICAZIONI ECOLOGICHE:**

GREENGUARD  
GREENGUARDGOLD



• **REPORT DI FONOASSORBIMENTO:**

UNI EN ISO 354: 2003  
UNI EN ISO 11654: 1998



## T-FRAME (SP 5 cm):

Sample description: "Panel Tailor made" total thickness 50 mm ± 20%.  
Mounting Type: Mounting Type A

Sample area: 11.95 m<sup>2</sup>  
Reverberation room volume: 161.3 m<sup>3</sup>

f [Hz]	$\alpha_s$ [-]
Frequency	Acoustic absorption coefficient values
100	0.15
125	0.24
160	0.39
200	0.47
250	0.64
315	0.69
400	0.79
500	0.86
630	0.93
800	0.96
1000	0.94
1250	0.95
1600	0.93
2000	0.89
2500	0.85
3150	0.80
4000	0.86
5000	0.90

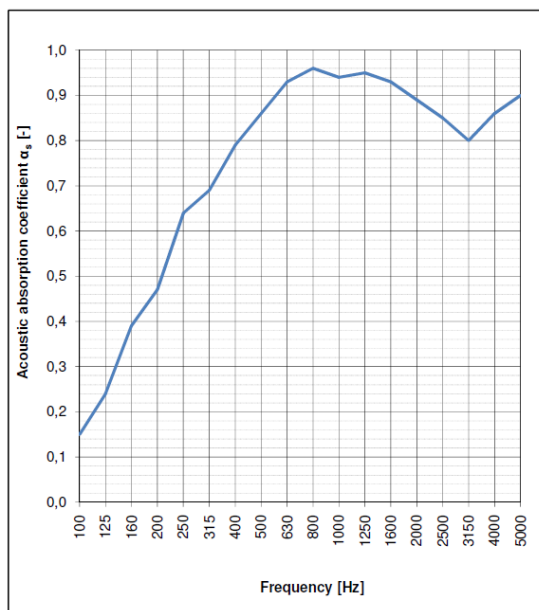

Evaluation based on laboratory measurement results by means of a technical method.



Apple green 463



Yellow 53



Light blue 386



Turquoise 366



Beige 532



White 999



Green tea 425



Carrot 66



Capri 379



Iceberg 377



Camel 533



Light grey 611T



Grass 464



Orange 120



Pastel blue 380



Queen blue 378



Tuscan brown 534



Pearl grey 643



Olive 426



Red 231



Steel blue 263



Sapphire 331



Tiger eye 119



Grey 629



Office green 443



Brick 572



Lavender 175



Office blue 332T



Brown sugar 569



Quartz grey 636



Forest green 496



Bordeaux 236



Red wine 234



Dark blue 334T



Taupe 607



Old silver 625



Peacock blue 411



Fuchsia 173



Purple 262



Midnight blue 333T



Dark mud 571



Black 651





Beige 952



Yellow 34



Quartz rose 940



Acid green 611E



Fresh air 976



Ghost white 955



Caramel 332E

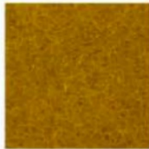

Mustard 54



Salmon 317



Cashmere green 89



Salvia green 334E



Chalk 327



Mushroom 325



Cob orange 997

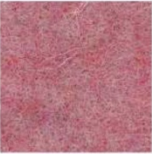

Blossom pink 335



Leaf green 910



Light blue 914



Grey 953



Chocolate 352



Orange 971



Pink 988

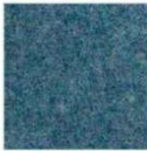

Avio 333E



Sky blue 942



Mineral blue 311



Taupe 511



Red 5



Violet 921



Lagoon 608



Blue yonder 200



Moonstone 512



Brown 605



Marsala 973



Purple 508



Peacock blue 962



Honolulu blue 607



Ink 329



Dark musk 22



Bordeaux 192



Grape 603



Blue 193



Deep sea blue 963

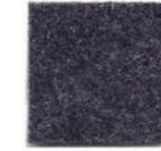



Dark grey 923

				
Grey 4	Yellow 3	Pink 17	Kiwy 28	Light blue 8
				
Beige 16	Orange 9	Opal 33	Acid green 7	Blue 13
				
Alabaster 32	Dark Orange 14	Fuchsia 10	Water green 2	Azure 1
				
Tuscan brown 20	Red 6	Purple 11	La salle green 12	Dark blue 5
				
Mud 19	Bordeaux 15	Grapes 23	Jungle green 31	Summer night 21
				
Rich black 18	Sangria 30	Pastel pink 37	Grey green 22	Pacific blue 29
				
Pale yellow 41	Ruby red 27	Wisteria pink 36	Celadon 39	Egg blue 38





				
Almond 505	Banana 51	Dark gold 52	Aqua green 455	Air blue 351
				
Sand 502	Mandarin 102	Pistachio 451	Teal blue 454	Ash grey 601
				
Rose 503	Cadmium 101	Foliage 452	Grey blue 301	Rock grey 602
				
Brown 504	Terra di Siena 103	Racing green 453	Orchid 251	Dark grey 603
				
Chestnut 552	Antique ruby 201	Old brown 553	Purple 252	Night blue 302
				
Berry 202	Red 211	Coffee 551	Blue 303	Full black 651

VELVET   



Beige 104



Mauve 23V



Yellow 26



Avio 16V



Grey 616



Cherry 10V



Bright green 12V



Graphite 617

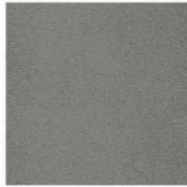

Taupe 205



Marsala 80

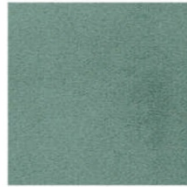

Salvia green 56



Deep sea blue 14V



Brown 100



Bordeaux 90



Lagoon 15V



Dark blue 666